

TB 9-4931-702-50

CHANGE 3

DEPARTMENT OF THE ARMY TECHNICAL BULLETIN

**CALIBRATION PROCEDURE FOR
DC TRANSFER STANDARD
JOHN FLUKE MODELS
730A AND 730A/AB**

Headquarters, Department of the Army, Washington, DC

20 August 2001

Approved for public release; distribution is unlimited.

TB 9-4931-702-50, 10 May 1974, is changed as follows:

1. Remove old pages and insert new pages as indicated below. New or changed material is indicated by a vertical bar in the margin of the page.

Remove pages

1 and 2

5 and 6

Insert pages

1 and 2

5 and 6

2. File this change sheet in front of the publication for reference purposes.

ERIC K. SHINSEKI
General, United States Army
Chief of Staff

OFFICIAL:

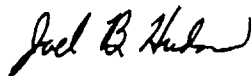

JOEL B. HUDSON
Administrative Assistant to the
Secretary of the Army

0120707

Distribution:

To be distributed in accordance with Std. IDS No. RLC-1500, 11 May, 1992.

PIN: 009083-003

TB 9-4931-702-50

Change 2

DEPARTMENT OF THE ARMY TECHNICAL BULLETIN

CALIBRATION PROCEDURE FOR DC TRANSFER STANDARD, JOHN FLUKE MODELS 730A AND 730A/AB

Headquarters, Department of the Army, Washington, DC
18 February 1986

TB 9-4931-702-50, 10 May 1974, is changed as follows:

Page 2. In table 2, item A2, Minimum Use Specifications column, add superscript ¹.

In table 2, add footnote to table as follows:

¹Prior to using the NULL DETECTOR, determine sensitivity on the 3 and 10 μ V ranges, using A1 and A4."

By Order of the Secretary of the Army:

JOHN A. WICKHAM, JR.
General, United States Army
Chief of Staff

Official:

MILDRED E. HEDBERG
Brigadier General, United States Army
The Adjutant General

Distribution:

To be distributed in accordance with Std. IDA No. RLC-1500, 17 June 1985.

US GOVERNMENT PRINTING OFFICE: 1987 - - 733-293/40535 REGION #4

PIN: 009083-002

TB 9-4931-702-50

Change 1

DEPARTMENT OF THE ARMY TECHNICAL BULLETIN

CALIBRATION PROCEDURE FOR DC TRANSFER STANDARD, JOHN FLUKE MODELS 730A AND 730A/AB

Headquarters, Department of the Army, Washington, DC
20 September 1984

TB 9-4931-702-50, 10 May 1974, is changed as follows:

Page 3. Figure 1 is superseded as follows:

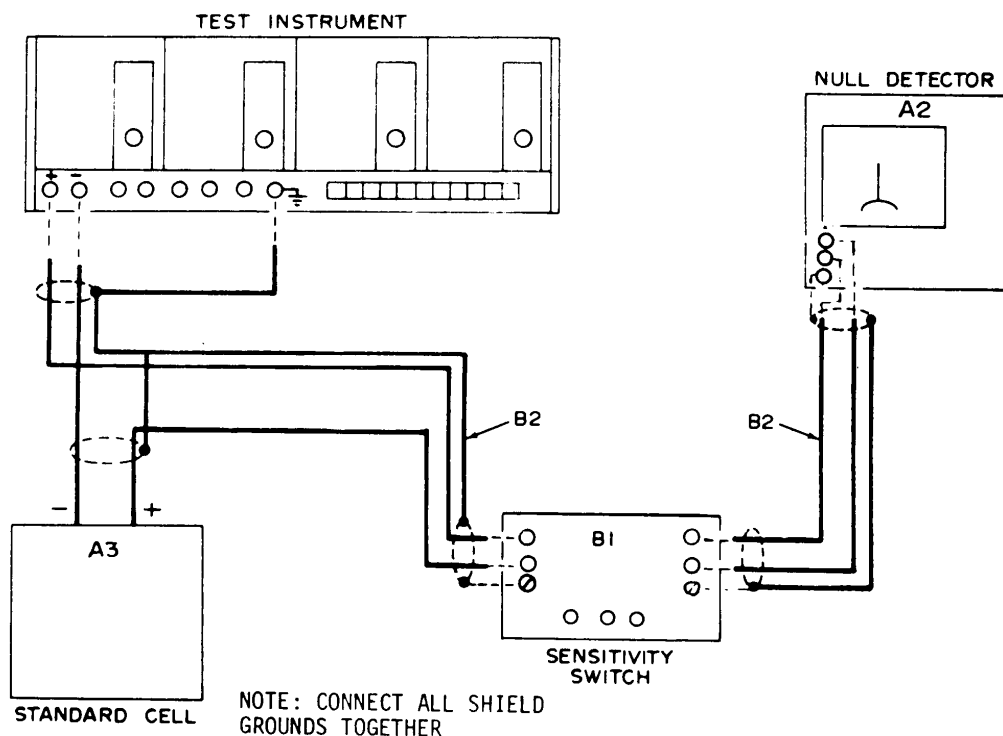

Figure 1. Absolute voltage - equipment setup.

PIN: 009083-001

Page 4. Figure 2 is superseded as follows:

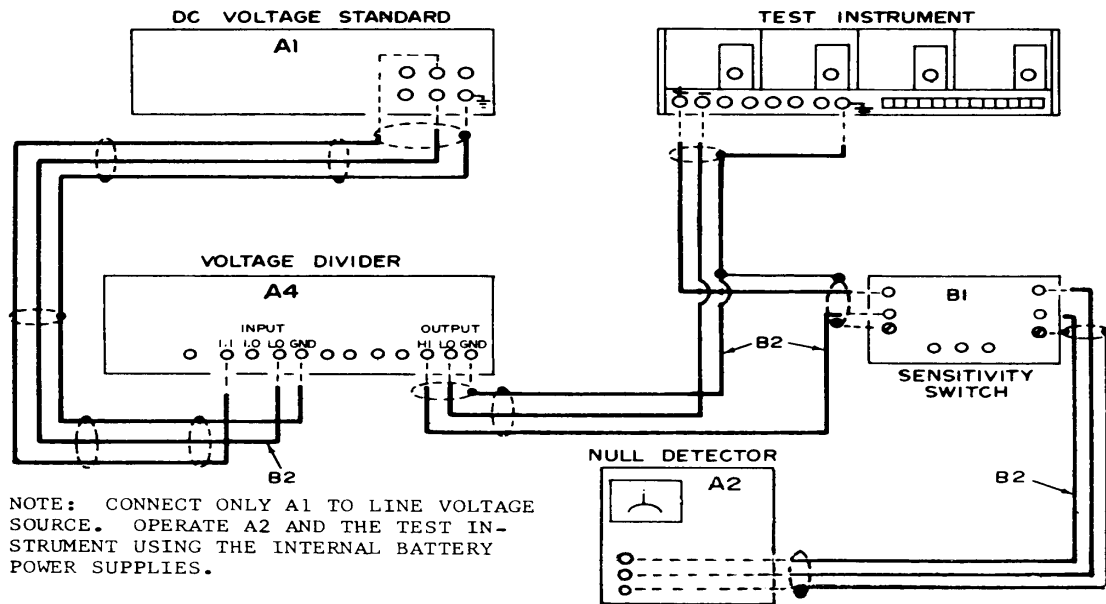

Figure 2. Output voltage - equipment setup.

Page 4, paragraph 9b. Add the note below, following the second note.

NOTE

Do not report the adjustments in this paragraph unless the applicable measurement in the performance check exceeds ± 10 microvolts.

Page 6, paragraph 10b. Add the note below, following the second note:

NOTE

Do not report the adjustments in this paragraph unless the applicable measurement in the performance check exceeds ± 10 microvolts.

By Order of the Secretary of the Army:

FRED C. WEYAND
General, United States Army
Chief of Staff

Official:

VERNE L. BOWERS
Major General, United States Army
The Adjutant General

Distribution:

To be distributed in accordance with Std. IDA No. RLC-1500, 17 June 1985.

TB 9-4931-702-50

DEPARTMENT OF THE ARMY TECHNICAL BULLETIN

CALIBRATION PROCEDURE FOR DC TRANSFER STANDARD, JOHN FLUKE MODELS 730A AND 730A/AB

Headquarters, Department of the Army, Washington, DC
10 May 1974

REPORTING OF ERRORS AND RECOMMENDED CHANGES

You can help improve this publication. If you find any mistakes or if you know of a way to improve the procedure, please let us know. Mail your letter or DA Form 2028 to: Commander, U. S. Army Aviation and Missile Command, ATTN: AMSAM-MMC-MA-NP, Redstone Arsenal, AL 35898-5230. A reply will be furnished to you. You may also send in your comments electronically to our e-mail address: 2028@redstone.army.mil, or FAX 256-842-6546/DSN 788-6546

SECTION		Paragraph	Page
	I. IDENTIFICATION AND DESCRIPTION		
	Test instrument identification.....	1	2
	Forms, records, and reports.....	2	2
	Calibration description.....	3	2
	II. EQUIPMENT REQUIREMENTS		
	Equipment required.....	4	3
	Accessories required.....	5	3
	III. CALIBRATION PROCESS		
	Preliminary instructions.....	6	3
	Loop closure.....	7	4
	Linearity of output resistance divider and Output voltage check (Model 730A).....	8	5
	Linearity of output resistance divider and Output voltage check (Model 730A/AB).....	9	9
	Final procedure.....	10	12

CHANGE 3

**SECTION I
IDENTIFICATION AND DESCRIPTION**

1. Test Instrument Identification. This bulletin provides instructions for the calibration of Dc Transfer Standard, John Fluke Models 730A and 730A/AB. The manufacturer's instruction manuals were used as the prime data source in compiling these instructions. The dc transfer standard will be referred to as the "TI" (test instrument) throughout this bulletin.

a. Model Variations. Variations among models are described in text.

b. Time and Technique. The time required for this calibration is approximately 4 hours, using the dc and low frequency technique.

2. Calibration Data Card, DA Form 2416

a. Forms, records, and reports required for calibration personnel at all levels are prescribed by TM 38-750. DA Form 2416 must be annotated in accordance with TM 38-750 for each calibration performed.

b. Adjustments to be reported on DA Form 2416 are designated (R) at the end of the sentence in which they appear. When adjustments are in tables, the (R) will follow the designated adjustment. Report only those adjustments made and designated with (R)

3. Calibration Description. TI parameters and performance specifications which pertain to this calibration are listed in table 1.

NOTE

For calibration of model 730A to be valid, the TI ΔE control must be set to the last 3 digits of the value of standard cell used in the calibration.

Table 1. Calibration description

Test Instrument Parameters	Performance Specifications
Accuracy (ARITH MEAN Of 1.018 ΔE Output). ¹	With $\pm 10 \mu V$ of calibrated value at end of calibration period.
Transfer Voltage Accuracy ²	10 V: $\pm 10 \mu V$ 1.00 V: $1 \mu V$ (1.018 ΔE): $\pm 1 \mu V$ (1.019 + ΔE): $\pm 1 \mu V$ ΔE : 0.0 To 999 μV In $1 \mu V$ Steps: $\pm 1 \mu V$

¹This value is not the manufacturer's specified value. This value is the maximum drift allowed over a 90-day period as determined for Army calibration applications.

²Accuracy to which voltage can be standardized.

SECTION II EQUIPMENT REQUIREMENTS

4. Equipment Required. Table 2 identifies the specific equipment used in this calibration procedure. This equipment is issued with secondary reference calibration standards set 4931-621-7878 and is to be used in performing this procedure. Alternate items may be used by the calibrating activity when the equipment listed in table 2 is not available. The items selected must be verified to perform satisfactorily prior to use and must bear evidence of current calibration. The equipment must meet or exceed the minimum use specifications listed in table 2. The accuracies listed in table 2 provide a four-to-one accuracy ratio between the standard and TI. Where the four-to-one ratio cannot be met, the actual accuracy of the equipment selected is shown in parenthesis.

5. Accessories Required. The accessories listed in table 3 are issued with secondary reference calibration standards set 4931-621-7878 are to be used in this calibration procedure. When necessary, these items may be substituted by equivalent items unless specifically prohibited.

Table 2. Minimum Specifications of Equipment Required

Item	Common Name	Minimum Use Specifications	Manufacturer, Model And Part Number
A1	DC VOLTAGE STANDARD	Range: 1.0 to 1.1 volts in 1 microvolt steps; 10.0 to 11 volts in 1-microvolt steps.	John Fluke, Model 332A (7911393) Or John Fluke, Model 332B/AF (6625-150-6994)
A2	NULL DETECTOR	Resolution: 0.25 ppm ¹	John Fluke, Model 845AB (6625-445-3333)
A3	STANDARD CELL	Test report specification	Guildine, Model 9154B (MIS-10364)
A4	VOLTAGE DIVIDER	Accuracy: ±0.25 ppm	ESI, Model RV-726 (MIS-10295)

¹Prior to using the NULL DETECTOR, determine sensitivity on the 3 and 10 μV ranges, using A1 and A4.

Table 3. Accessories Required

Item	Common Name	Description And Part Number
B1	SENSITIVITY SWITCH	Sensitivity and reversing switch; galvanometer key (7913207)
B2	WIRE	No. 18 AWG, shielded pair, solid copper conductor; electrical power cable (MIL-10312).

SECTION III CALIBRATION PROCESS

6. Preliminary Instructions

a. The instructions outlined in this paragraph are preparatory to the calibration process. Personnel should become familiar with the entire bulletin before beginning the calibration.

b. Items of equipment used in this procedure are referenced within the text by common name and item identification number as listed in tables 2 and 3. For the identification of equipment referenced by item numbers prefixed with A, see table 2, and for prefix B, see table 3.

WARNING

HIGH VOLTAGE is used during the performance of this calibration. DEATH ON CONTACT may result if personnel fail to observe safety precautions.

NOTE

Unless otherwise specified, verify the results of each test and take corrective action whenever, the test requirement is not met before continuing with the calibration.

7. Loop Closure Check

NOTE

If this is initial calibration of the TI, omit this paragraph and begin with paragraph 8 below.

- (1) Connect equipment as shown in figure 1.

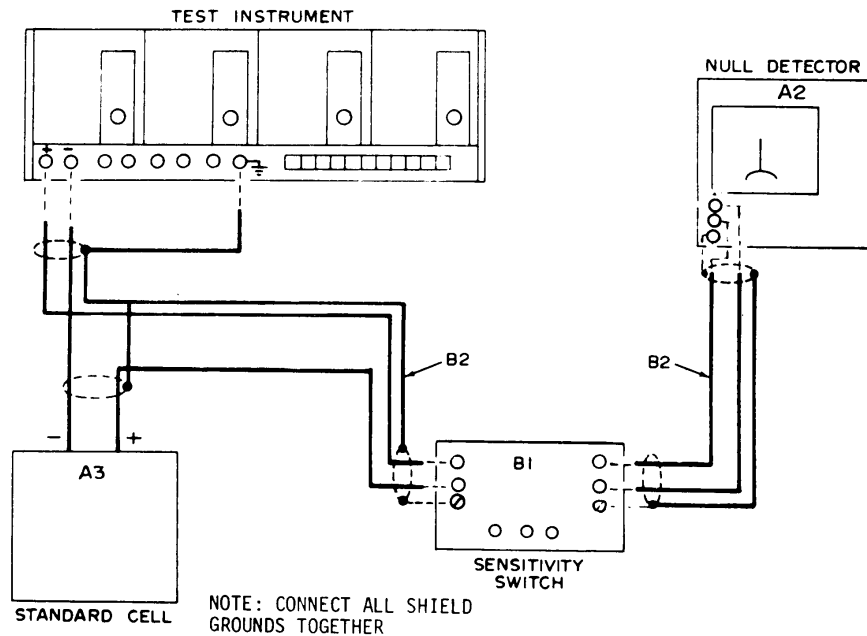

Figure 1. Absolute voltage - equipment setup.

- (2) Ensure that the sensitivity switch (B1) is open.

CAUTION

Avoid damaging or destroying the standard cell (A3) by insuring that the TI output is set to the correct voltage and adjusted as described in the procedure before operating the sensitivity switch.

- (3) Energize equipment and allow sufficient time for warm-up and stabilization.

- (4) Set TI controls as follows:

- (a) Set function selectors and ΔE controls to standard cell value recorded at last calibration.

- (b) Depress ARITH MEAN pushbutton.

- (5) Check and record the deviation of the TI ARZTH MEAN output from value recorded at last calibration. Deviation of the two values will be within ± 10 microvolts. If not, the calibrations performed during the loop may be invalid. An explanation of appropriate action taken will be recorded to verify loop completion.

NOTE

The values recorded during the loop closure check and explanations of appropriate action taken with an out-of-tolerance reading will be maintained for 3 years.

8. Linearity of Output Resistance Divider and Output Voltage Check (Model 730A)

a. Performance Check

- (1) Connect equipment as shown in figure 2.

- (2) Position TI controls as listed below:

- (a) Supply No. 1 function switch to 10V and set ΔE control to the last 3 digits of standard cell (A3) certified value.

- (b) EXT COMPARISON/OUTPUT 1 depressed.

- (3) Set voltage divider (A4) to 1.0000000.

- (4) Set dc voltage standard (A1) to 10.999999.

- (5) Operate dc voltage standard, sensitivity switch (B1), and null detector (A2) to obtain null on null detector.

TB 9-4931-702-50

- (6) Open sensitivity switch.
- (7) Set voltage divider to .1000000.
- (8) Set TI supply No. 1 function switch to 1V.

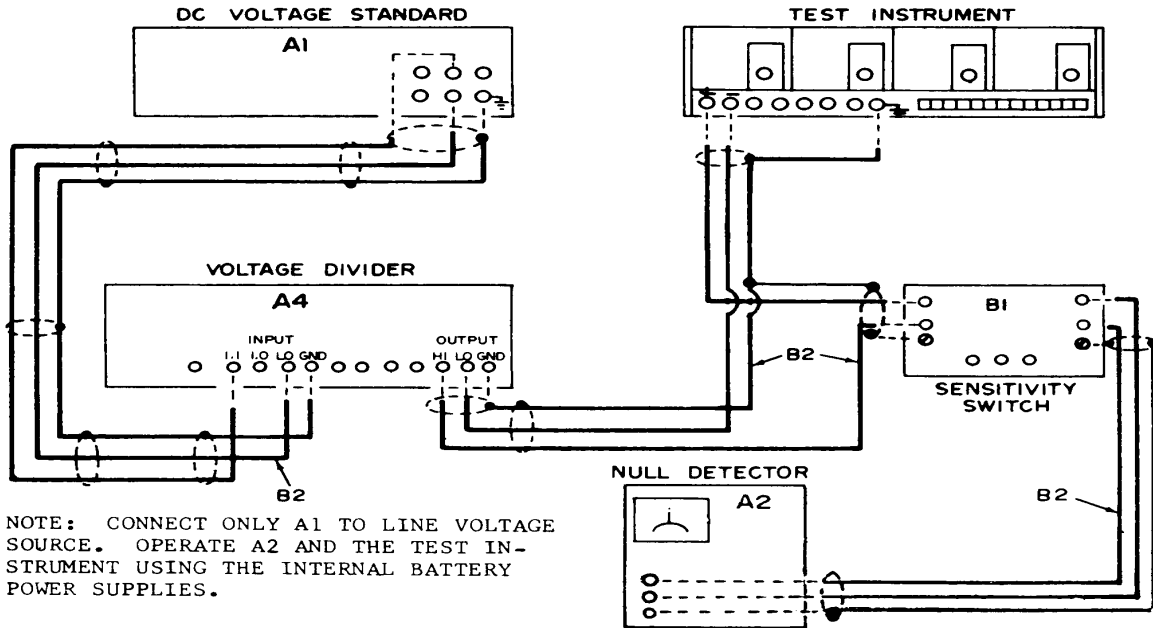

Figure 2. Output Voltage - equipment setup

- (9) Operate sensitivity switch. If null detector indication is not within ± 1 microvolt of null, perform **b(1)** below.
- (10) Open sensitivity switch.
- (11) Set voltage divider to 1.0000000.
- (12) Set dc voltage standard to 1.099999.
- (13) Operate dc voltage standard, sensitivity switch, and null detector to obtain null on null detector.
- (14) Open sensitivity switch.
- (15) Set voltage divider to standard cell value.
- (16) Position TI supply No. 1 functions switch to 1.018 $+\Delta E$ and ΔE control to last 3 digits of standard cell value (should already be).

6 CHANGE 3

TB 9-4931-702-50

(17) Operate sensitivity-switch. If null detector indication is not within ± 1 microvolt of null, perform **b(2)** below.

(18) Open sensitivity switch.

(19) Set voltage divider to 1.019---0. (The 3 blanks represent last 3 digits of standard cell value.)

(20) Set TI supply No. 1 function switch to $1.019 \pm \Delta E$.

(21) Operate sensitivity switch. If null detector indication is not within ± 1 microvolt of null, perform **b(3)** below.

(22) Open sensitivity switch.

(23) Set voltage divider to 1.0199990.

(24) Set TI supply No. 1 ΔE control to 999.

(25) Operate sensitivity switch. If null detector indication is not within ± 1 microvolt of null, perform **b(4)** below.

(26) Open sensitivity switch.

(27) Set voltage divider to .0009990.

(28) Set TI supply No. 1 function switch to ΔE .

(29) Operate sensitivity switch. If null detector indication is not within ± 1 microvolt of null, perform **b(5)** below.

(30) Open sensitivity switch.

(31) Repeat technique of (1) through (30) above for supplies 2, 3, and 4.

(32) Connect equipment as shown in figure 1.

(33) Set TI supply No. 1 function switch and ΔE control for output equal to standard cell certified value.

(34) Operate the sensitivity switch. If null detector indication is not within ± 1 microvolt of null, perform **b(6)** below.

(35) Open sensitivity switch.

(36) Repeat technique of (33) through (35) above for supplies 2, 3, and 4.

TB 9-4931-702-50

(37) Depress ARITH MEAN pushbutton with all four supplies set at standard cell value. If null detector indication is not within ± 1 microvolt of null, repeat (1) through (36) above. Record ARITH MEAN output value for use in loop closure check.

(38) Affix label to TI showing standard cell value used for calibration and a statement to the effect that the ΔE control must be set to the last 3 digits of the standard cell value for calibration to be valid.

b. Adjustments

NOTE

Remove TI protective cover only to make adjustments. Replace for indications.

NOTE

In (1) through (4) and (6) below, the designation of the adjustments for each reference supply is the same. When reporting these adjustments, the component designator must be prefaced with the proper supply designator. For example: if working with supply No. 1, R25 should be reported as A3A1R25; if working with supply No. 3, R25 should be reported as A3A3R25

NOTE

Do not report the adjustments in this paragraph unless the applicable measurement in the performance check exceeds ± 10 microvolts.

(1) Adjust supply No. 1. "1V CAL" control (R25, fig. 3) to obtain null on null detector (R)

(2) Adjust supply No. 1, "1.018 CAL" control (R17, fig. 3) to obtain null on null detector (R).

(3) Adjust supply No. 1, "1.019 CAL" control (R18, fig. 3) to obtain null on null detector (R)

(4) Adjust supply No. 1, " 1.018/1.019 ΔE CAL" control (R19, fig. 3) to obtain null on null detector (R)

(5) Adjust supply No. 1, " ΔE CAL" control (R5, fig. 3) to obtain null on null detector (R).

NOTE

In (5) above all four " ΔE CAL" controls are designated R5. They are four different adjustments and all are located on

the main PCB board A3 (fig. 3). When reporting those adjustments, the component designator must be prefaced with supply number begin adjusted. For example: if working, with supply No. 1, report supply No. 1 R5; if working, with supply No. 3, report supply No. R5.

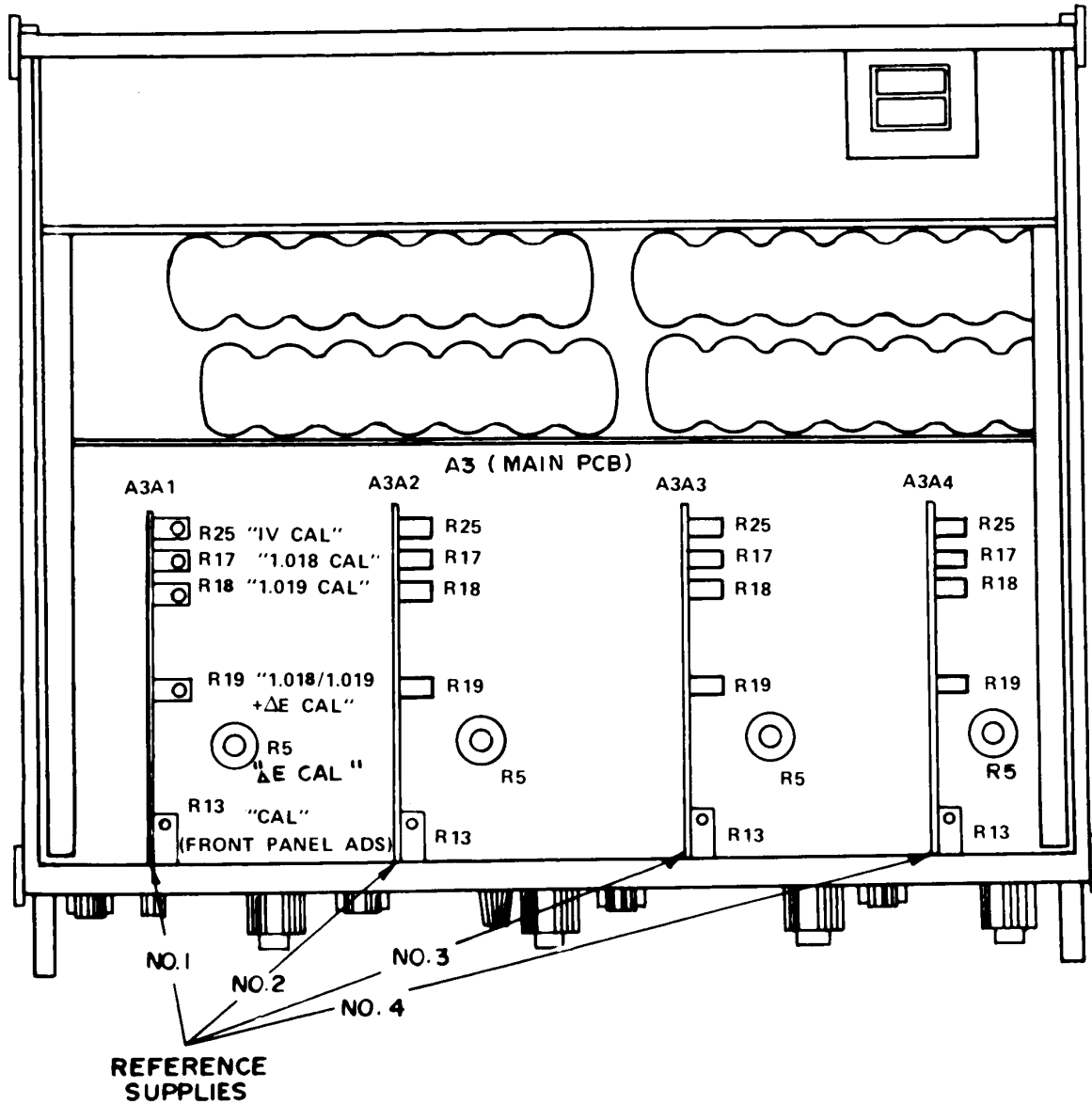

Figure 3. Test instrument (model 730A) - internal view.

- (R) (6) Adjust supply No. 1 "CAL" control (R13, fig. 3) to obtain null on null detector

TB 9-4931-702-50

9. Linearity of Output Resistance Divider and Output Voltage Check (Model 730A/AB)

a. Performance Check

- (1) Connect equipment as shown in figure 2.
- (2) Position 11 controls as listed below:
 - (a) Supply No. 1 function switch to 10V.
 - (b) Supply No. 1 ΔE control to 000.
 - (c) EXT COMPARISON/OUTPUT 1 depressed.
- (3) Set voltage divider (A4) to 1.0000000.
- (4) Set dc voltage standard (A1) to 10.999999.
- (5) Operate dc voltage standard, sensitivity switch (B1), and null detector (A2) to obtain null on null detector.
- (6) Open sensitivity switch.
- (7) Set voltage divider to .1000000.
- (8) Set TI supply No. 1 function switch to 1V.
- (9) Operate sensitivity switch. If indication is not within ± 1 microvolt of null, perform **b**(1) below.
- (10) Open sensitivity switch.
- (11) Set voltage divider to 1.0000000.
- (12) Set dc voltage standard to 1.099999.
- (13) Operate dc voltage standard, sensitivity switch, and null detector to obtain null on null detector.
- (14) Open sensitivity switch.
- (15) Set voltage divider to 1.018000.
- (16) Position TI supply No. 1 function switch to 1.018 + ΔE .

(17) Operate sensitivity switch. If null detector indication is not within ± 1 microvolt of null, perform **b(2)** below.

(18) Open sensitivity switch.

(19) Set voltage divider to 1.0190000.

(20) Set TI supply No. 1 function switch to $1.019 + \Delta E$.

(21) Operate sensitivity switch. If null detector indication is not within ± 1 microvolt of null, perform **b(3)** below.

(22) Open sensitivity switch.

(23) Set voltage divider to 1.0199990.

(24) Set TI supply No. 1 ΔE control to 999.

(25) Operate sensitivity switch. If null detector indication is not within ± 1 microvolt of null, perform **b(4)** below.

(26) Open sensitivity switch.

(27) Set voltage divider to .0009990.

(28) Set TI supply No. 1 function switch to ΔE .

(29) Operate sensitivity switch. If null detector indication is not within ± 1 microvolt of null, perform **b(5)** below.

(30) Open sensitivity switch.

(31) Repeat technique of (1) through (30) above for supplies 2, 3, and 4.

(32) Connect equipment as shown in figure 1.

(33) Set TI supply No. function switch and ΔE control for output equal to standard cell (A3) certified value.

(34) Operate sensitivity switch. If null detector indication is not within ± 1 microvolt of null, perform **b(6)** below.

(35) Open sensitivity switch.

(36) Repeat technique of (33) through (35) above for supplies No. 2, 3, and 4.

TB 9-4931-702-50

(37) Depress ARITH MEAN pushbutton with all four supplies set at standard cell value. If null detector indication is not within ± 1 microvolt of null, repeat (1) through (36) above. Record ARITH MEAN output value for use in loop closure check.

(38) Affix label to TI showing standard cell value used for calibration.

b. Adjustments

NOTE

Remove TI protective cover only to make adjustments.
Replace for indications.

NOTE

In (1) through (4) and (6) below, the designation of the adjustments for each reference supply is the same. When reporting these adjustments, the component designator must be prefaced with the proper supply designator. For example: if working with supply No. 1, R25 should be reported as A3A1R25; if working with supply No. 3, R25 should be reported as A3A3R25

NOTE

Do not report the adjustments in this paragraph unless the applicable measurement in the performance check exceeds ± 10 microvolts.

(1) Adjust supply No. 1 "1V CAL" control (R19, fig. 4) to obtain null on null detector (R).

(2) Adjust supply No. 1 "1.018 CAL" control (R17, fig. 4) to obtain null on null detector (R).

(3) Adjust supply No. 1 "1.019 CAL" control (R15, fig. 4) to obtain null on null detector (R).

(4) Adjust supply No. 1 "1.018/1.019 $+\Delta E$ CAL" control (R12, fig. 4) to obtain null on null detector (R).

(5) Adjust supply No. 1 " ΔE CAL" control (R4, fig. 4) to obtain null on null detector (R). (For supply No. 2 adjust R8 (R), supply No. 3 adjust R12 (R), and supply No. 4 adjust R16 (R))

(6) Adjust supply No. 1 "CAL" control (R11, fig. 4) to obtain null on null detector (R).

10. Final Procedure

- a. Deenergize and disconnect all equipment.
- b. In accordance with TM 38-750, annotate and affix DA Label 80 (U.S. Army Calibration System). When the TI cannot be adjusted within tolerance, annotate and affix DA Form 2417 (Unserviceable or Limited Use)

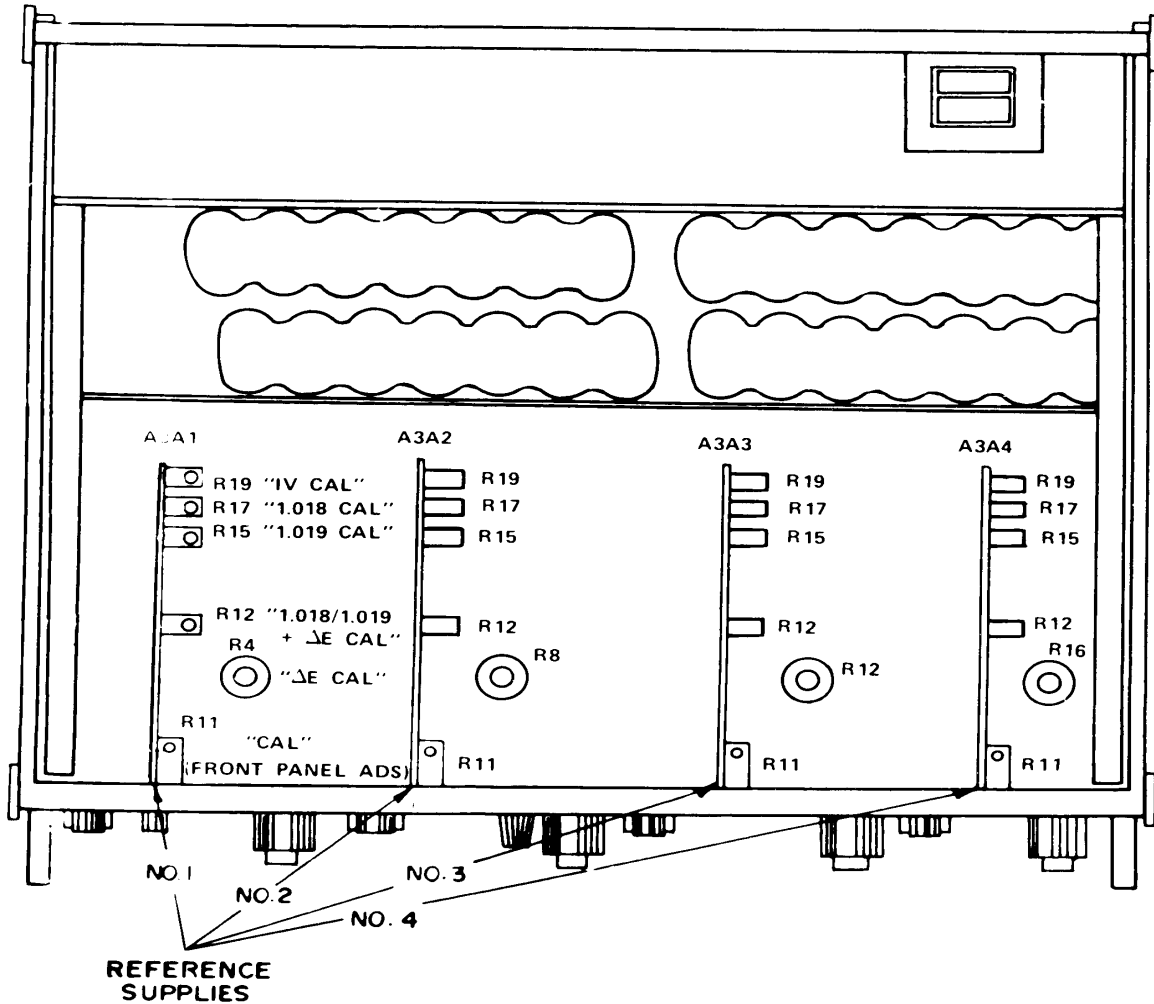

Figure 4. Test instrument (model 730A/AB) - internal view.

TB 9-4931-702-50

By Order of the Secretary of the Army:

CREIGHTON W. ABRAMS
General, United States Army
Chief Of Staff

Official:

VERNE L. BOWERS
Major General, United States Army
The Adjutant General

DISTRIBUTION:

To be distributed in accordance with Std. IDS No. RLC-1500, 13 March 1974..

US GOVERNMENT PRINTING OFFICE: 1974 - 747699/256

PIN NO: 009083-003